

RONGTA **USER MANUAL**

80MM THERMAL RECEIPT PRINTER

RP336/RP336A/RP336B

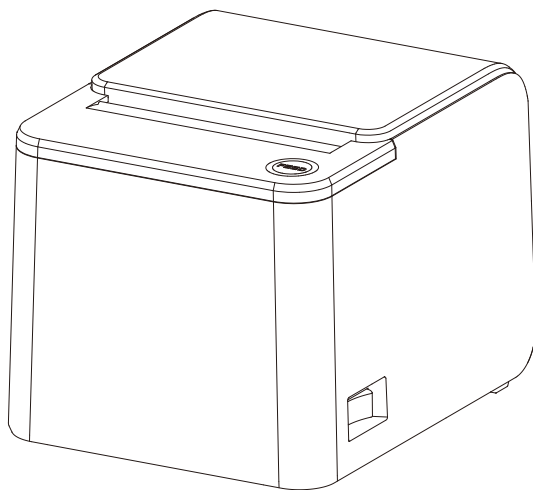



Catalogue

Introduction	2
Safety Instructions.....	3
I. Product Introduction.....	4
1.1 Product Specifications.....	4
1.2 Unpacking List.....	5
1.3 Appearance and Structure	6
1.4 Product size	9
II. Installation and use.....	12
2.1 Power Connection	12
2.2 Loading Paper	13
2.3 Basic Functions	14
III. Drive installation instructions	16
3.1 Driver Download.....	16
3.2 Installing Drivers on Windows.....	16
3.3 Port Direct Drive.....	17
3.4 Set up and test the printer	18
IV. Printer setup tool instructions	28
4.1 Tool Download.....	28
4.2 Usage Instructions	28
4.3 Connecting a Printer	28
4.4 The "Download" function in the main screen.....	30
4.5 The [Set Printer] function in the main screen.....	31
V. Page change parameter operation description.....	43
5.1 Obtaining the IP address of the Printer	43
5.2 Connect the printer.....	43
5.3 Change parameter	44
5.4 Set Ethernet port parameters	45
VI. Clean the printer	47
6.1 Clean print head	47
6.2 Cleaning Sensors.....	47
6.3 Clean the printing roller.....	48
VII. Troubleshooting	49
7.1 Indicators on the control panel are off.....	49
7.2 The indicator is normal, but the printer does not print	49
7.3 Clearing clip	49
Appendix 1 Interface information	50
Appendix 2 Description of special connection functions	53

Introduction

Thank you for purchasing our Thermal Receipt Printer. This thermal receipt printer takes reasonable Safe, reliable and efficient printing quality at an affordable price. At the same time, the printer has strong functions and easy operation It is widely used in shopping malls, supermarkets, hospitals, restaurants, banks, gas stations, road and bridge tolls and other fields. This manual explains in detail how to install and use the printer, and describes in detail how to perform the printer Setup and maintenance, and provide solutions to common printer failures.

Symbolic convention

Symbol	Instructions
	Note Provides additional information to emphasize or supplement important points in the main text.
	Indicates a warm reminder

Version record

Version number	Release date	Instructions
V1.0	2024.04	This is the first official release

 The illustrations and descriptions used in this manual may differ from the actual ones.

Safety Instructions

Before operating and using the printer, please carefully read the following items and strictly observe the use rules.

- ① Please install the printer on a stable surface to avoid printer suffered from any vibration and shocks.
- ② Stop using keeping the product in any case of unusual circumstances such as the presence of high temperature, high humidity and serious pollution.
- ③ Connect the printer's power adapter to an appropriate grounding socket. Avoid using the same socket with large motors or other equipment that may cause voltage fluctuation of power supply.
- ④ Do not get the product wet. Do not insert foreign objects(e.g. metal) into the product, and once it occurs, immediately turn off the power supply.
- ⑤ Never use the printer without paper, otherwise it will seriously damage the printing rubber roller and thermal head.
- ⑥ Unplug the product from the power outlet if the printer is idle for a long time.
- ⑦ Do not disassemble or modify the product personally.
- ⑧ Use only the power adapter specified in this instruction.
- ⑨ In order to ensure the printing quality and prolong the service life of the product, it is recommended to use the recommended or equivalent thermal printing paper.
- ⑩ Do not plug/unplug the product with the product powered on.
- ⑪ When plugging and unplugging the printer power cord, please hold the arrow position of the printer power connector with your hand, not the cord of the printer power cord.
- ⑫ Please keep this manual for the future use and reference.

Safety warning

 **Note:** The tearing blade has a sharp edge, please be careful not to touch to prevent cuts.

 **Warning:** The print head is a hot part, during the printing process or just after printing, Do not touch the print head and surrounding parts, children must use it under adult supervision.

 **Warning:** Do not touch thermal printhead surfaces and connectors. Avoid electrostatic damage to the print head.



I. Product Introduction

1.1 Product Specifications

item		Parameter
Print	Printing mode	Line thermal printing
	Effective resolution	203 dpi
	Print speed	200mm/s
	Maximum print width	72 or 48mm
Detect	Sensor	Cover opening detection, paper detection
Consumable	Paper type	Continuous paper
	Paper width	58mm or 80mm
	Paper thickness	0.06mm-0.08mm
	Printing paper outer diameter	80mm
Programming language		ESC/POS
Software	Actuate	XP/Win7/Win8/Win10/Windows11/Linux CUPS/MacOS/OPOS
Built-in font		ASCII Font: FontA 12x24 , FontB 9x17 Chinese character: 24x24
Bar code	One-dimensional	UPC-A/UPCE/JAN8(EAN8)/JAN13(EAN13)/ CODE 39/CODE93/CODE128/ITF/CODABAR
	QR code	PDF417, QR code
Communication interface		Standard: USB, Cash box Options: Network port, Bluetooth, WiFi
Power source	Power adapter	AC 100 ~ 240V
	Input power supply	DC 24V  1.5A
Environmental parameter	Operating temperature	0~45°C
	Working humidity	20~90%(no condensation)
	Storage temperature	-10~60°C
	Storage humidity	10-90%(no condensation)
Physical parameter	Size (L * W * H)	RP336: 167*140*124mm RP336A: 167*140*132mm RP336B: 167*140*130mm
	Weight	RP336: 660g / RP336A: 670g / RP336B: 665g
Authentication		CCC、CE、FCC

1.2 Unpacking List

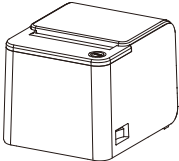
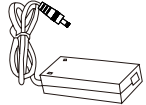
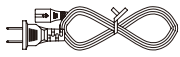
Once you receive the printer, first check to see if the printer was damaged during shipping. You can check the packing box, The appearance of the printer and whether the accessories are damaged. In the event of damage to the carriage, file a written claim with the carrier immediately. If any accessories are missing, Please contact the seller immediately.

 <p>Main machine</p>	 <p>Power adapter</p>	 <p>Power cord</p>
 <p>Paper roll</p>	 <p>USB cable</p>	

☺ The pictures are for reference only, please subject to practicality.

1.3 Appearance and Structure

RP336

Front View

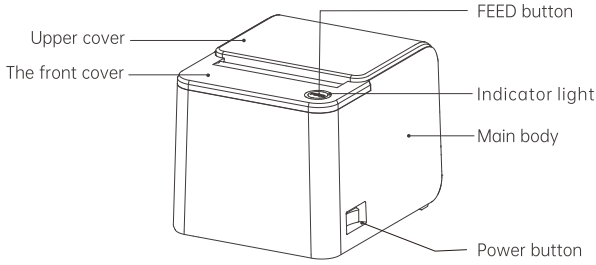

Rear View

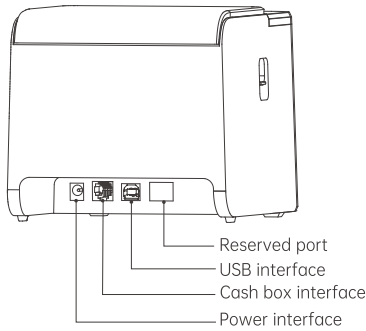

Inside View

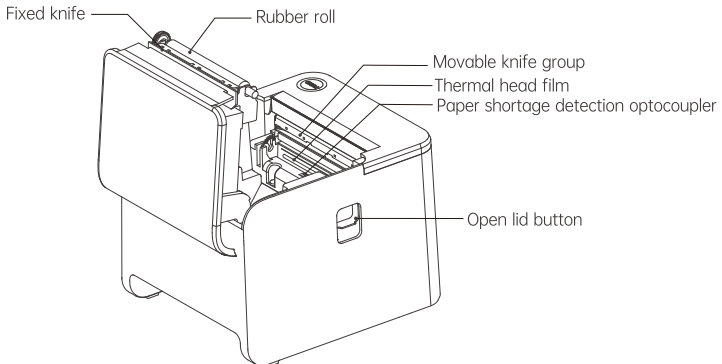

RP336A

Front View

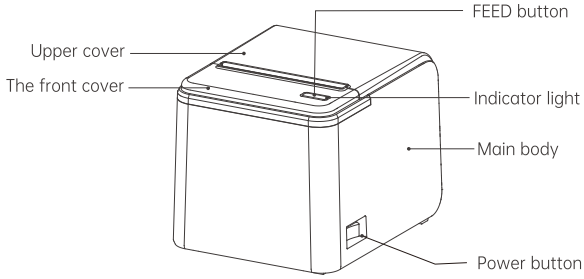

Rear View

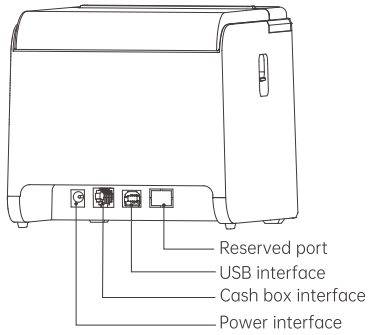

Inside View

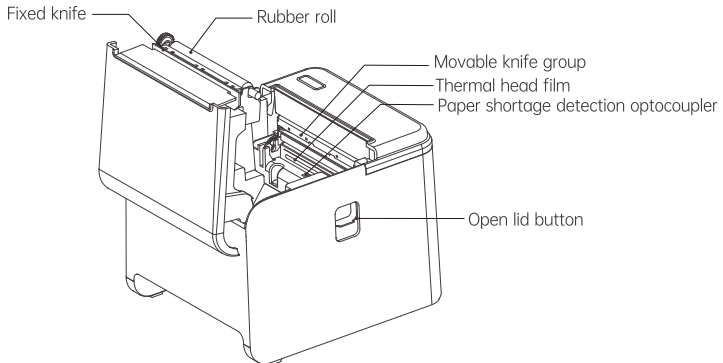

RP336B

Front View

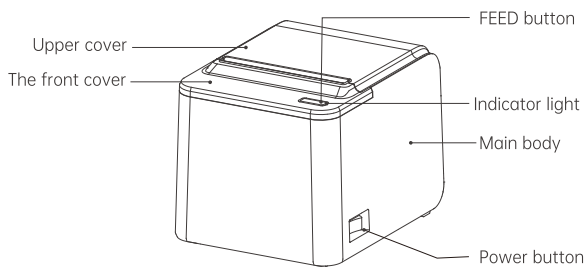

Rear View

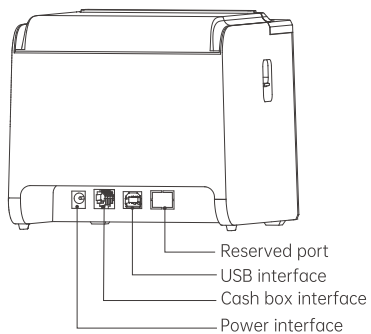

Inside View

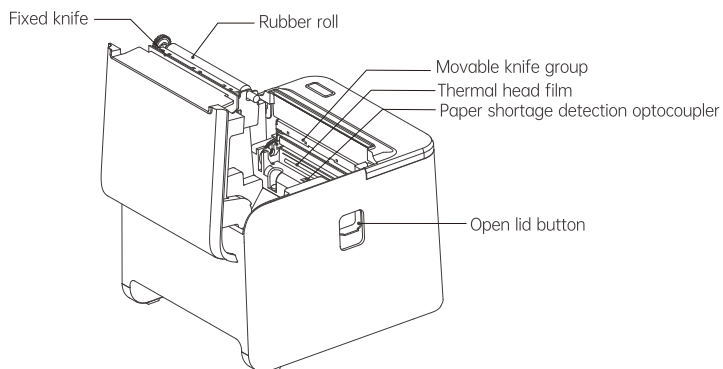

1.4 Product size

RP336

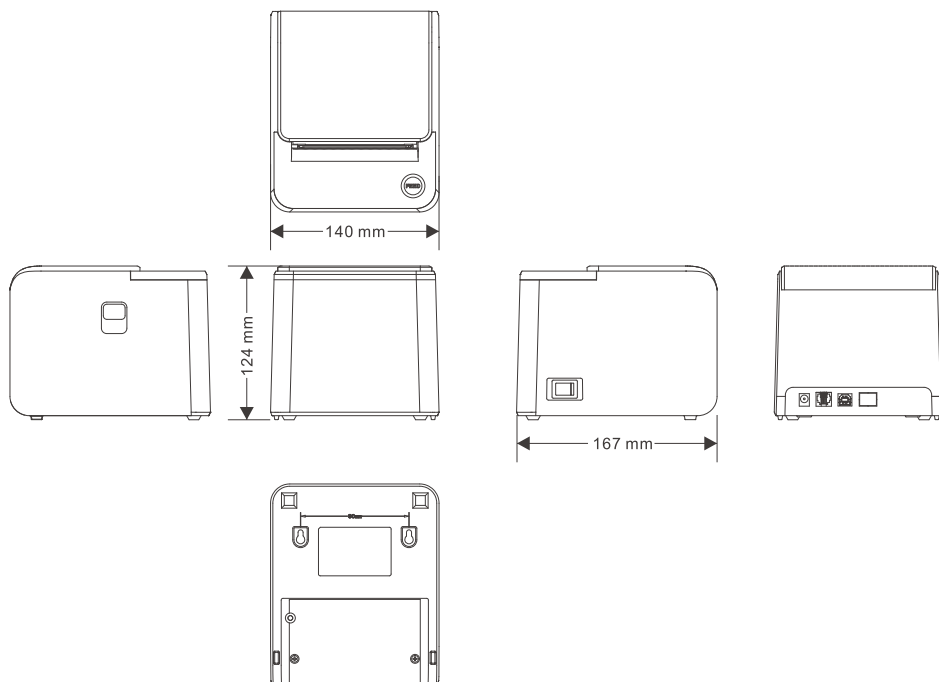

RP336A

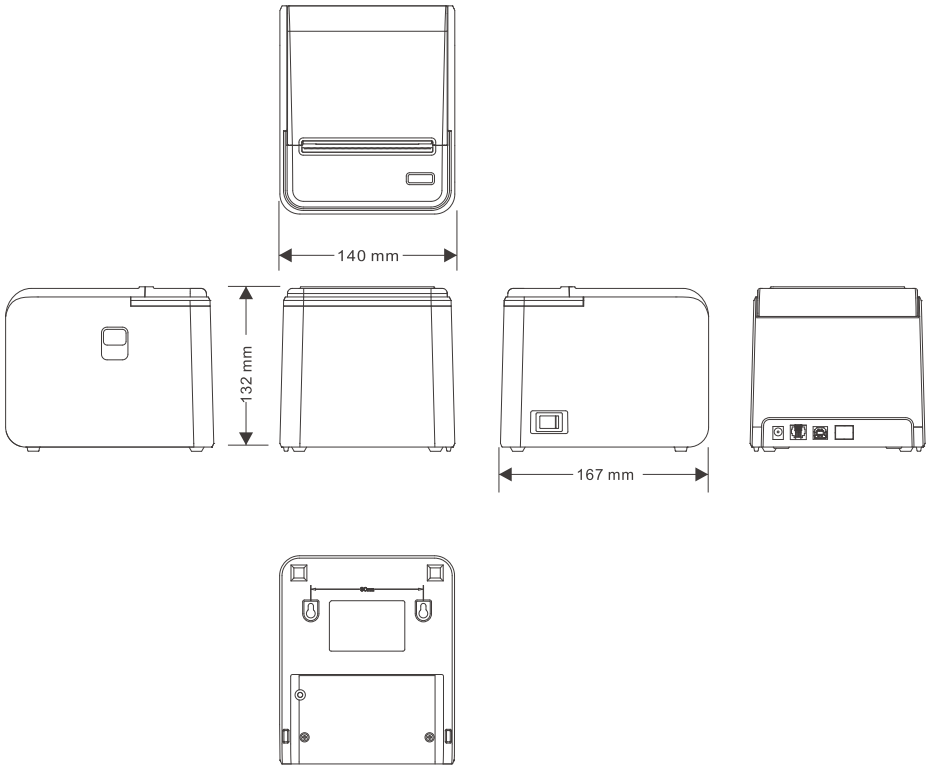

RP336B

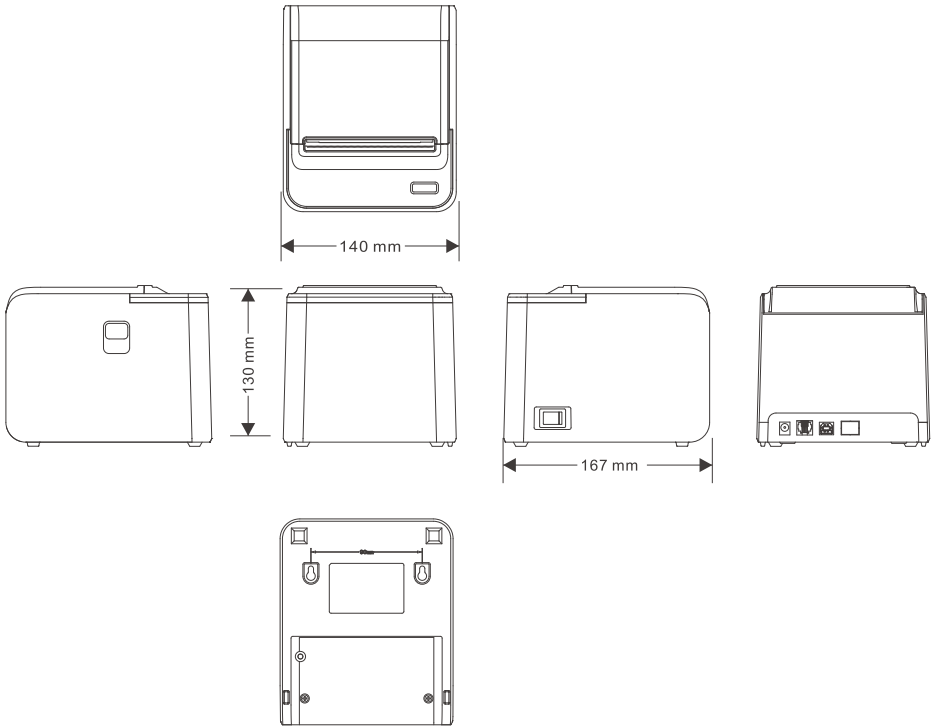

II. Installation and use

2.1 Power Connection

- (1) Make sure that both the printer and the PC host are turned off, plug the matching data communication cable into the printer's data interface, and plug the other end into the serial port/parallel port /USB/ network port of PC host.
- (2) If equipped with an electrically openable cashbox, insert the RJ-11 connector on the cashbox into the cashbox interface of the printer (the specifications of the cashbox must conform to the printer cashbox drive specifications).
- (3) Connect to the special power adapter of the printer.

Use the special power adapter for the printer.
The connection diagram is as follows:

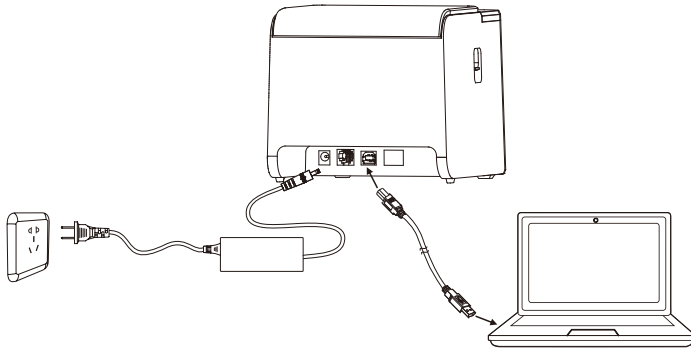

Attention:

- (1) First plug the power plug DC24V of the printer, then switch on the AC220V power supply, and then turn on the power switch. Do not reverse the sequence, otherwise the machine will be damaged.
- (2) Using an improper power adapter will make the printing quality worse and even damage the printer.
- (3) Do not connect the telephone line to the cashbox interface, otherwise the printer and telephone may be damaged.
- (4) When plugging in the printer power cord, please hold the arrow position of the printer power connector with your hand (do not plug in the cord of the printer power cord with your hand). Forcibly plucking the flexible cord of the printer power connector or pulling the printer power cord may cause damage to the printer or the power adapter.

2.2 Loading Paper

The thermal receipt printer uses an 80 mm thermal paper roll and adopts an easy paper loading mechanism, which is very convenient for paper loading.

The installation method of thermal paper is as follows:

- (1) Open the printer cover.
- (2) Place the thermal paper roll into the paper loading bin as shown in Figure 1 below.
- (3) Pull the printing paper out of the paper outlet and close the upper cover as shown in Figures 2 and 3.

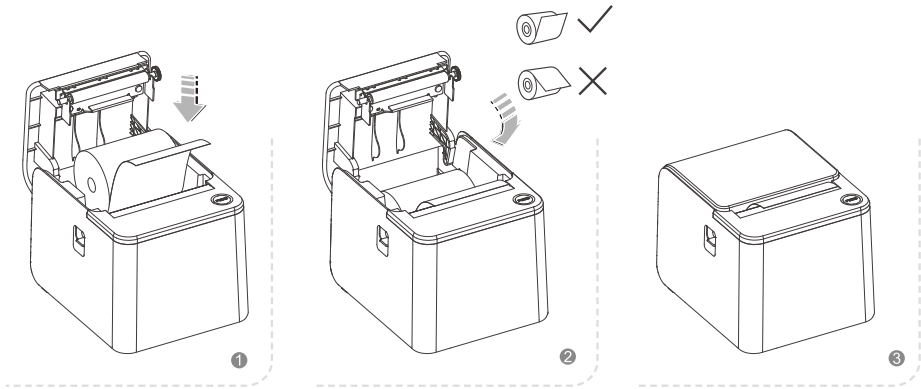

☺ Note: The printer can be divided into front paper and top paper.

2.3 Basic function description

(1) Power switch

The power switch is used to turn the printer on and off. The printer's power switch is located on the left side of the printer. When the "I" of the switch is pressed, the printer is turned on; when the "O" of the switch is pressed, the printer is turned off.



Note: Turn on the switch only after the power is connected.

Button and indicator light function description:

FEED button: paper feed button

In standby mode, press the paper feed button to continuously feed paper.

During the printing process, The paper feed button is invalid.

Press and hold this button before the printer is powered on to perform the printer self-test after powering on.

Power indicator light: solid blue: the power supply is normal and the printer is normal Always on after connected to power

Error indicator light: red

Printer error flashing indication, such as paper shortage, paper jam, print head overheating, Print head errors or other abnormalities, etc.

(3) Printer self-test

The self-test can detect whether the printer is working properly. If the self-test list sample can be printed correctly, it indicates that everything is normal except for the connection interface with the host, otherwise it needs to be repaired. The self-test will print out the software version number, printing density, interface form, English characters and some Chinese characters in sequence.

The operation method of self-test: after the printer is connected, press and hold down the paper FEED button and then turn on the printer power. First, the printer reset detection. After the reset is completed, release the feed button less than 5 seconds, and then the printer will self-test and print out the self-test list sample.

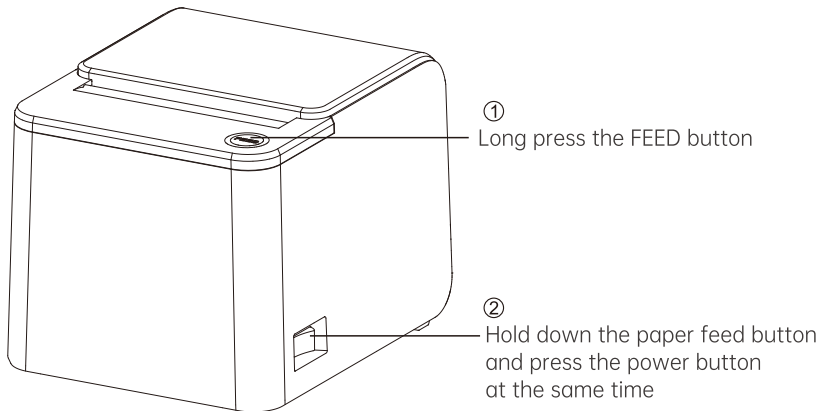

III. Driver installation instructions

3.1 Driver Download

(1) Go to www.rongtatech.com

(2) Click Service and Support, find the driver download: Thermal receipt printer driver (58, 80 series) Click download.

There are two kinds of thermal paper printer driver way, a Windows9x / 7/8/10 / ME / 2000 / XP/Linux/Mac under direct install driver, another is to use port direct drive.

3.2 Installing Drivers on Windows

 **Note:** Before installing the driver, ensure that the power supply is connected and the USB cable is connected to the computer

Add a printer in Windows, and specify the driver file in the driver disk to Windows, you only need to call the print command in the program to start printing.

Run `RongTaDriverInstall` to install the printer driver. The dialog box shown in the figure below pops up:

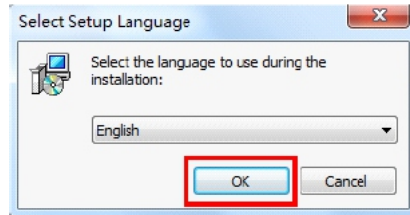

(2) Select the installation language and click "OK", as shown in the figure above.

Dialog box as shown below: click [Install]

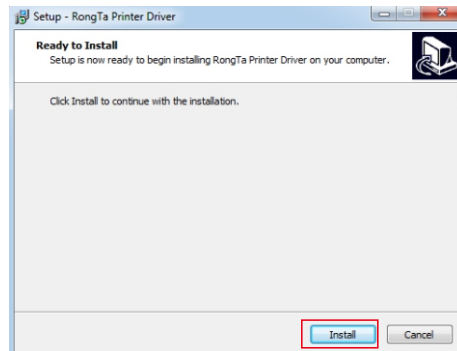

(3) Finally click as shown in the image below [Finish]

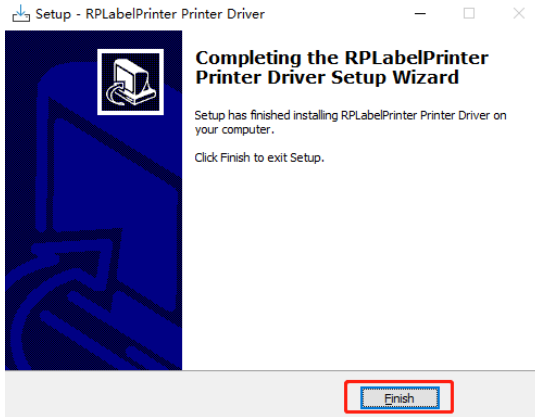

At this point, the printer driver installation is complete.

3.3 Port direct drive

In this way, there is no need to use the driver, only need to output the characters directly to the port, and by the printer's internal hard character library to achieve character conversion printing. Using the port direct drive mode, its printing mode is also changed from the page printing mode to the line printing mode, which makes the printing control more convenient. If used In the port direct drive mode, you need to use the command set to control the printing of the printer. For the specific print command set supported, please refer to the "Print command" option in the "Technical Parameter Table" on page 6 of this manual.

3.4 Set up and test the printer

(1) Set printer properties

After installing the printer driver, view "Start"-> "Control Panel"->"Printer and Fax"-> "Printer Properties" of RONG TA 80mm Series Printer. The "Printer Properties" window will pop up, as shown in the figure below:

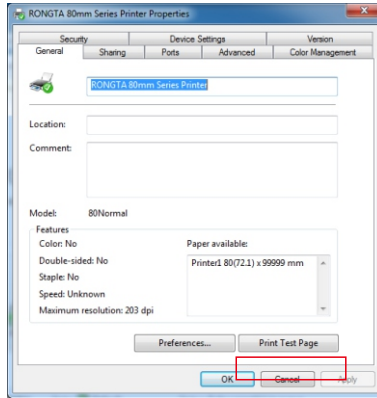

(2) Print Test Page via Serial Port

Select "Port" as shown in the figure above. As shown in the figure below:

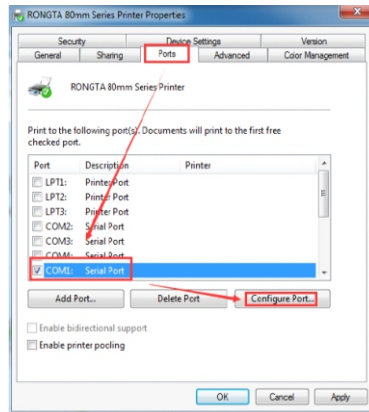

Select the corresponding serial port (take COM1 as an example), select COM1, and then select the configuration port. The following dialog box appears: Set the value of bits per second to be the same as the printer baud rate. If the baud rate is 19200, then set the value of bits per second in the serial port properties selected for printing as 19200.

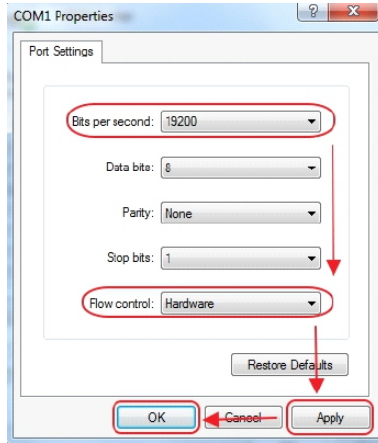

After settings are completed, click "OK" to save the settings. Back to the "Printer Properties" window, select "Apply (A)", as shown in the figure below:

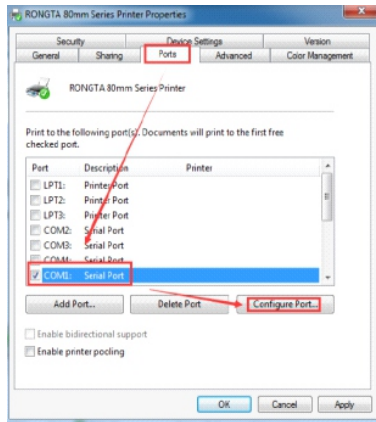

After the serial port configuration is completed, select "General", as shown in the figure below:

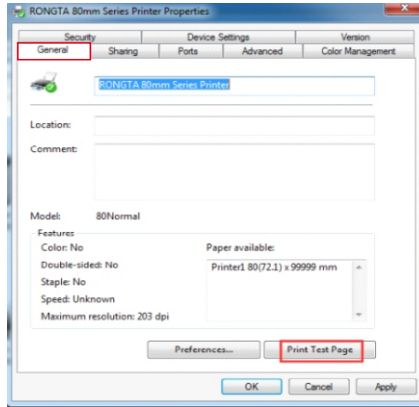

Select "Print Test Page (T)". If the test page can be successfully printed, it means the printer has been connected to the PC and configured correctly, and the printer port can be used normally.

(3) Print Test Page via USB Port

Print Test Page via USB Port

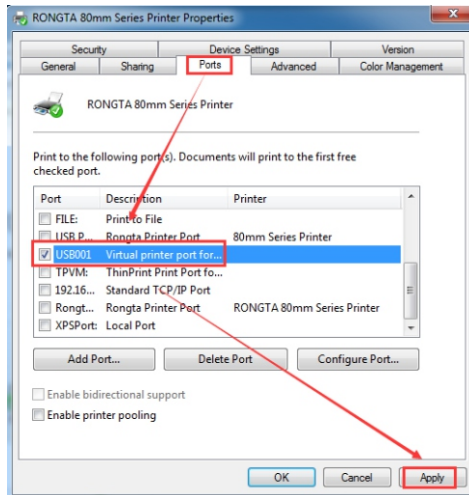

Then select "Apply" as shown in the figure above:

Then select "General" as shown in the figure below:

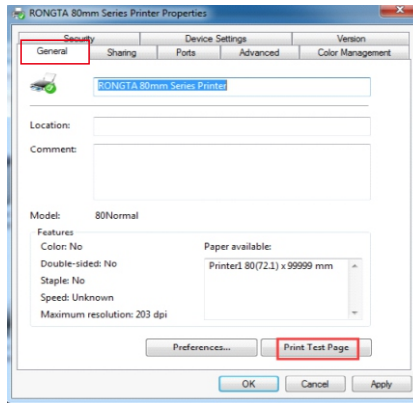

Select "Print Test Page (T)". If the test page can be successfully printed, it means the printer has been connected to the PC and configured correctly, and the printer port can be used normally.

(4) Print Test Page via Network Port

Open the Printer Properties

Select "Add Port " as shown in the figure above.

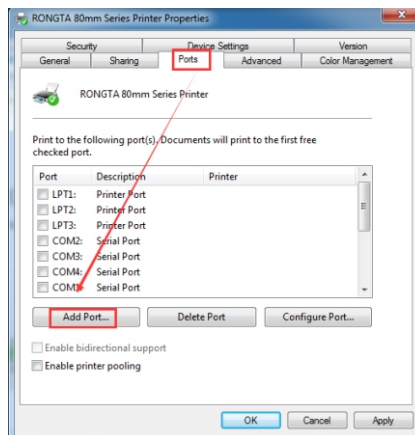

Select "New Port ...", as shown in the figure above.

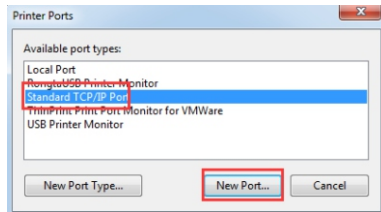

Select "Next", as shown in the figure above

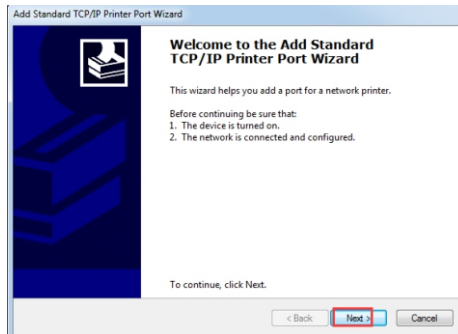

Then enter "192.168.1.87" after the "Printer Name or IP address (A)", and then select "Next", as shown in figure above

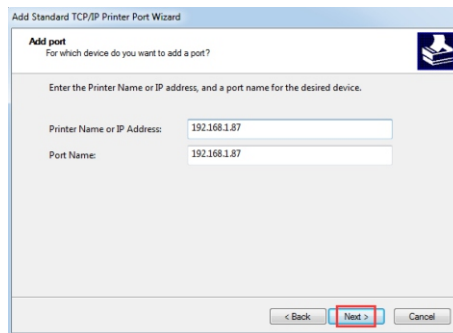

Then select "Next ", as shown in figure above

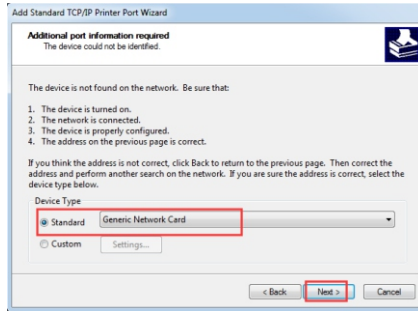

Then select "Finish", that is, a standard TCP/IP port is added.

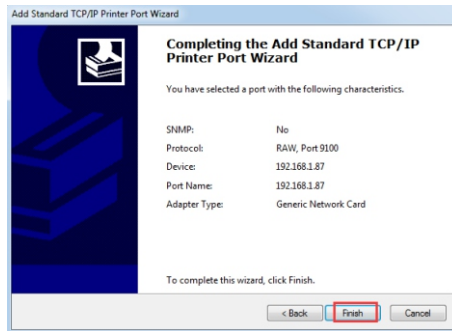

Select 192.16... Standard TCP/IP Port then select "Apply (A)" as shown in the figure above, select "General" as shown in the figure below.

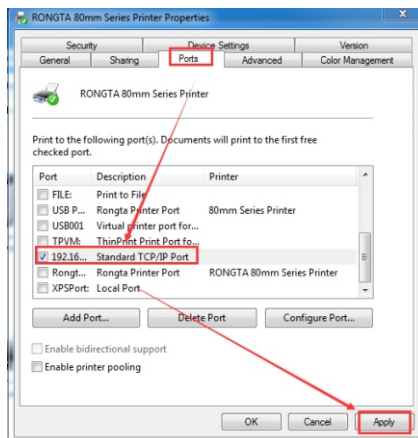

Select "Print Test Page (T)". If the test page can be successfully printed, it means the printer has been connected to the PC and configured correctly, and the printer port can be used normally.

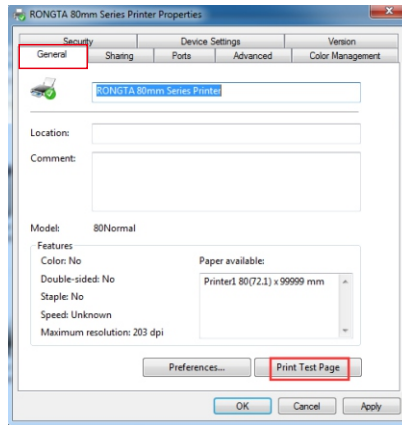

(5) Print Test Page via Parallel Port

Select a port among "LPT1: Printer Port, LPT2: Printer Port, LPT3: Printer Port". The port connected with a parallel port line should be selected. Take "LPT1: Printer Port" as an example below.

Select "Apply", as shown in the figure above.

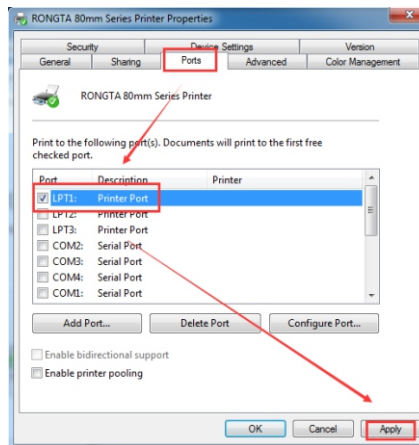

Select "General", as shown in the figure below.

Select "Print Test Page (T)". If the test page can be successfully printed, it means the printer has been connected to the PC and configured correctly, and the printer port can be used normally.

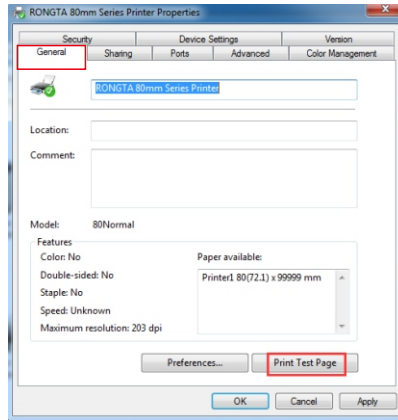

(6) Diffusion knife and Cashbox Settings

Select the Printer Properties, and click "Print Preference Pages"

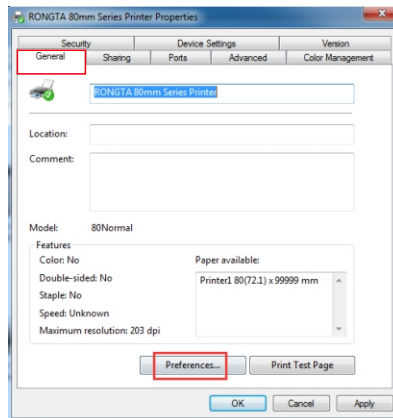

The driver has been set to automatically cut paper and open the Cashbox by default. If you need to change the settings, please follow the instructions below: Select "Paper/Quality", choose whether to cut paper in the "Paper Source" option, for example Report (Cut) is automatic paper cutting, the diffusion knife will automatically cut the paper after the test page is printed. The "Media" option is to choose whether the Cashbox works. After the selection, click "Apply" and "OK" to complete the settings.

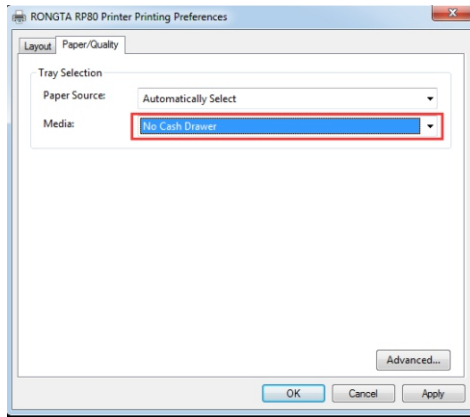

(2) Voice Function

The function only supports some models.

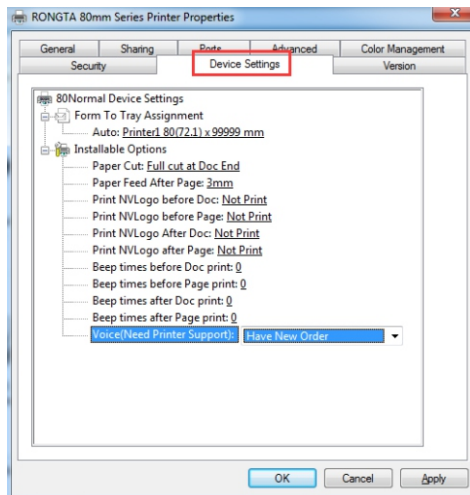

Select the Printer Properties, and click "Device Settings"
Click the Voice Function, select the ringtone to be set, and click "Apply".

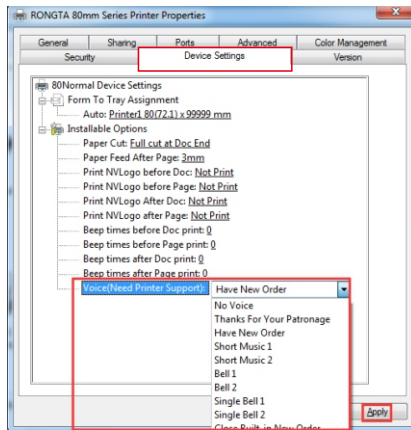

Click "General" and select "Print Test Page", and there will be voice when printing.

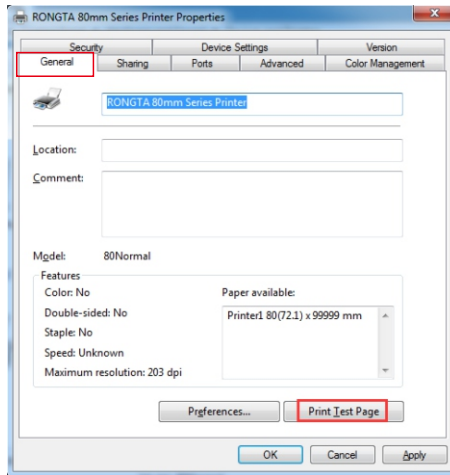

IV. Printer setup tool instructions

4.1 Tool Download

- (1) Go to www.rongtatech.com
- (2) Click Service and Support, find [Tool download], find [thermal receipt printer tool] and click download

4.2 Usage Instructions

The printer must be ready before using the setup tool:

- (1) Make sure that the printer is connected to the power supply and is in the shutdown state;
- (2) The communication cable used is inserted into the communication connection plug of the corresponding printer;
- (3) Confirm that the printer has installed the paper roll;
- (4) Turn on the power switch;

4.3 Connecting a Printer

Double-click tool [RongtaPrinterTool.exe], the following interface appears, as shown in the following picture, there are 3 ways to connect to the printer.

(1) If the printer is connected to USB, then directly select USB, and then [set the printer] or the program [download] (if the printer is connected to USB, then USB can be selected, if not, then the USB option is gray, can not be selected, as shown in the following figure).

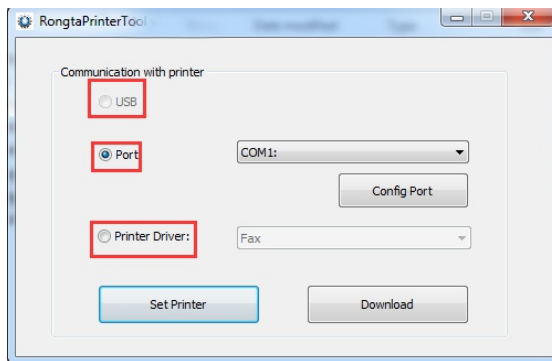

(2) Connect the printer through the port

The port can be connected to the printer after [Port Settings] through the serial port or network port, and then [Set printer].Or carry out the program [Download].

a. Select a serial port and configure the serial port

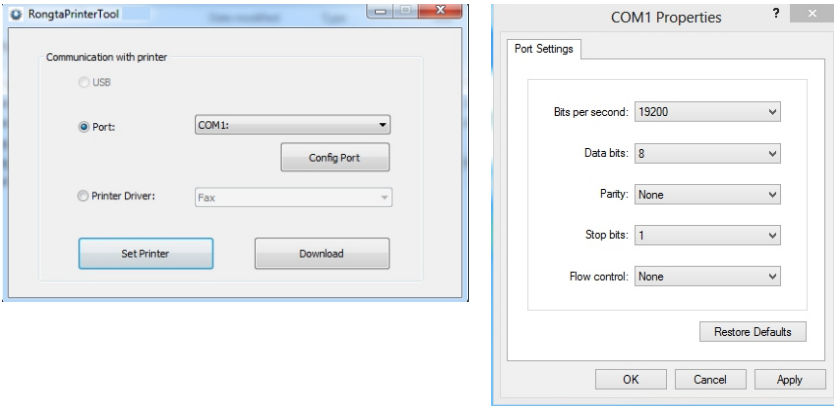

b. Select a network port, set an IP address, and connect the printer

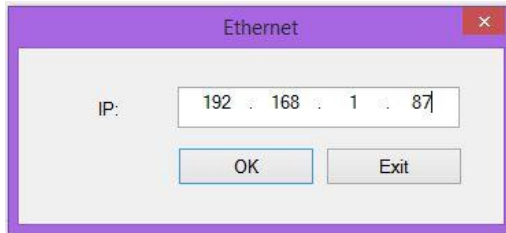

(3) Connect the printer through the common driver connection method (need to select and set the corresponding port of the driver first), and then [set the printer] or the program [download].

4.4 The "Download" function in the main screen

(1) After clicking [Download], the following interface appears to update [program]. Click [Open file], select the corresponding program path, and click "Update" to update the program.

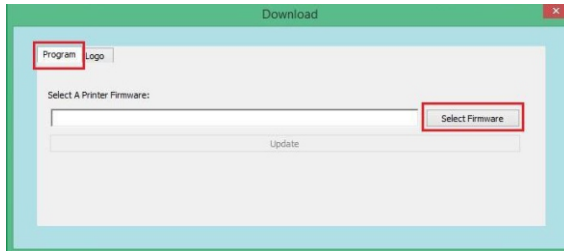

(2) Add "Picture". Select "LOGO", click "Add", select the corresponding path, and add LOGO to the printer.

Note: In this tool, the added LOGO only supports pictures in bmp format (black and white bitmaps, or 32-bit full-color bitmaps), and other formats are not supported. The requirements for the supported bitmap size are as follows:

a. The picture size must be less than 64k

b. Picture width requirements are:

The width of 80 shall be less than 576 pixels.

The width of 58 shall be less than 384 pixels.

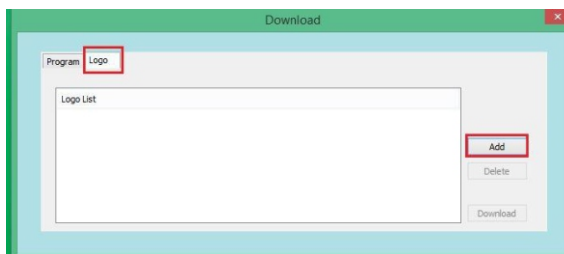

4.5 The [Set Printer] function in the main screen

Select [Set Printer] in the main screen

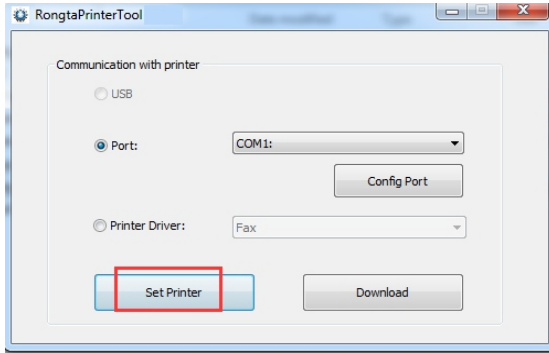

It mainly includes 14 interfaces.

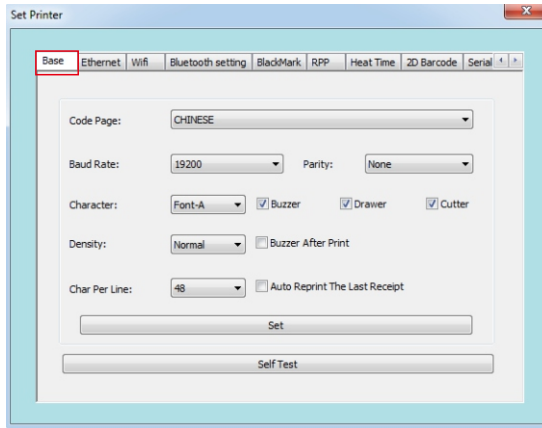

(1) Basic Settings

User can set the printer's language, baud rate, font, print density, cashbox, diffusion knife, etc. according to his needs, and then perform "Print Self-test Page" to check whether the change is complete.

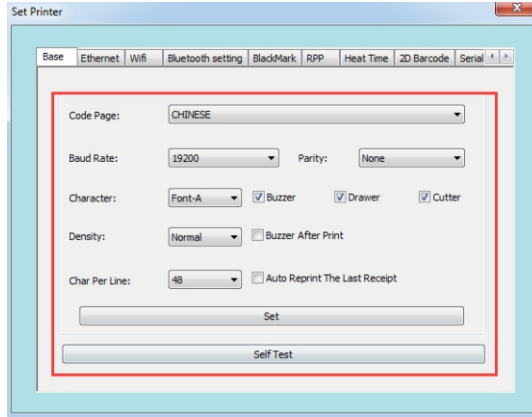

⚠ Note: If you use a serial port for printing, after the baud rate is changed, you need to return to the main screen to reconfigure the baud rate of the serial port before using the setting tool again.

(2) Ethernet

- Set the IP address of the printer, change it to "192.168.1.87", and set the communication port
- Set the printer's subnet mask and change it to "255.255.255.0"
- Set the printer's gateway as "192.168.1.1"
- Set the printer's DHCP function. The printer's DHCP is disabled by default. If necessary, it can be enabled to make the printer automatically obtain the address
- Set the Mac address and set the network transmission rate.

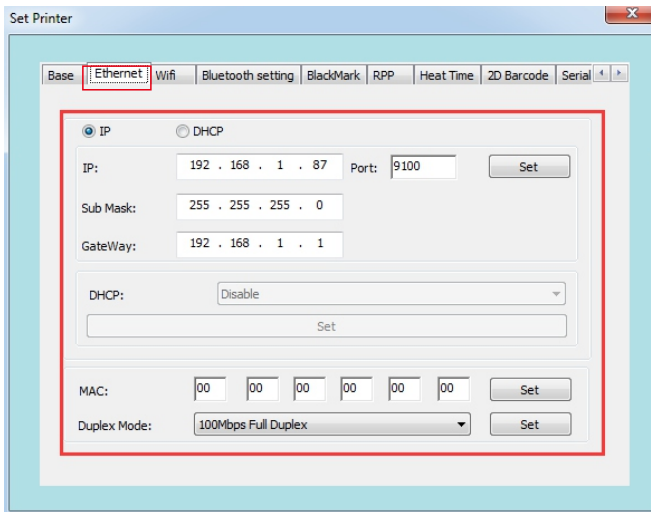

⚠ Attention: Before setting the web address, if the printer is connected with one of following two methods: "One" uses the "Internet port", "Two" the IP address in the print driver mode. After changing the IP, the printer's IP address is changed. At this point, the printer is disconnected from the tool, and the IP address of the tool needs to be reset before connecting the printer. Other connection methods are not affected.

(3) WiFi Settings

If the printer has wireless, you need to set the parameters for WiFi.

- [Wireless router setting instruction](#)

a. Set the SSID, namely the router name, in the WiFi settings of the router.

b. Wireless network security settings

1) Do not enable wireless security" can be selected;

2) If encryption is required, WPA-PSK/WPA2-PSK is recommended. The authentication type can be one of "Auto", "WPA-PSK", and "WPA2-PSK".

The recommended encryption algorithm is AES. PSK password can be set by yourself.

3) Wireless network security settings can also use WEP type, which is not recommended. If you have to adopt this authentication type, you can choose one of "Auto", "Open System", and "Shared Key". For the WEP key format, please select "ASCII code". The password can be defined by yourself.

- WiFi printer parameter setting instruction

- 1) Open the integrated setting tool " RongtaPrinterTool " included in the CD
- 2) According to the instruction manual of this setting tool, first make sure that the printer is connected.
- 3)Open the setting tool and select "WiFi".
- 4) Input the SSID (WiFi name) to which the printer is connected, and the corresponding mode.
- 5) Enter the WiFi encryption type and the WiFi password, as shown in the figure. For example, add WiFi rdhz, with the password encryption type of WPA-PSK, enter the WiFi password, and click "Set".
- 6) After clicking "Set", the printer will print the set WiFi parameters. Please print a self-test page and compare the printed WiFi parameters with those of the router. If matched, please wait patiently and the printer will connect to the WiFi within 1 minute. If not matched, please reset and repeat the above steps. Note: The factory default IP address of the printer is 192.168.1.87. If the printer's IP address and the wireless router's IP address are not on the same network segment, you need to set the printer's IP address to ensure the two addresses are on the same network segment. For specific IP address settings, please refer to 3.2 "Ethernet" settings.
WEP key format, please select "ASCII code". The password can be defined by yourself.

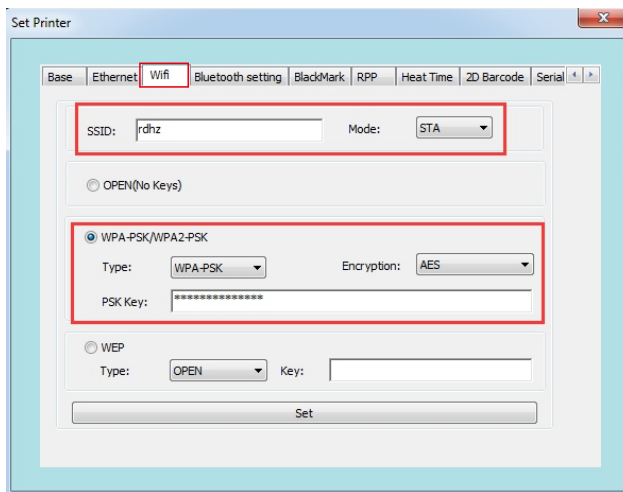

(4) Bluetooth Settings

If the printer has Bluetooth function, you can set the Bluetooth parameters.

- a. First press and hold the FEED button of the printer, and then turn on the printer to print the self-test page. From the self-test page, find out the Bluetooth pairing name and password of the printer.
- b. The Bluetooth pairing name and password can be changed if necessary. At this time, the "Bluetooth Settings" function in the integrated setting tool needs to be used, as shown in the figure below.
- c. Enter the new "Device Name" and "Pin" for the printer Bluetooth, and click "Set". After the printer is restarted, the settings are changed successfully.
- d. Power on the main device and search for the external Bluetooth device
- e. Find the Bluetooth printer just changed and enter the corresponding password to complete the pairing. When pairing, the printer must be on.

⚠ Note: During pairing, please do not turn on multiple printers at the same time; otherwise, you may not be able to judge which printer was successfully paired.

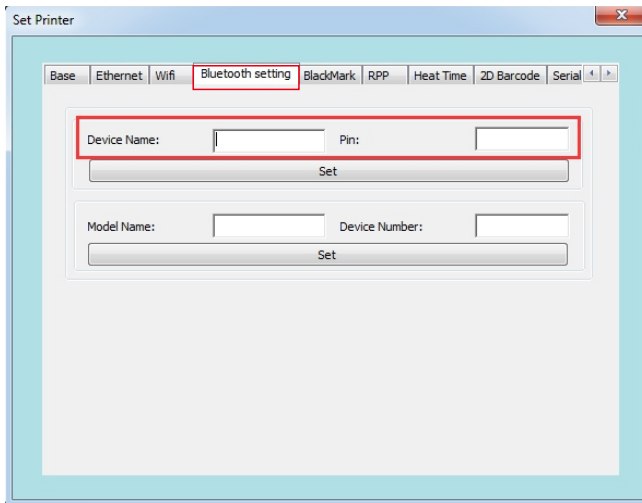

(5) [Black label] Settings

- a. "Enable Black Mark" is used to enable the black mark function. The printer will beep once if it is enabled successfully;
- b. After enabling black mark, turn off the printer and then turn it on again. You must restart the printer before setting the black mark parameters.
- c. Enter the length of the black-marked paper, that is, the length of paper between the two black marks. The setting value should be greater than the actual length of the black-marked paper. For example, if the length of the black-marked paper is 200mm, the setting value can be 400mm. After inputting, click "Set". If the setting is successful, the printer will beep once.
- d. If you input 10mm for "print start position", the printer will start printing from the position 10mm after the black mark. After inputting, click "Set". If the setting is successful, the printer will beep once.
- e. The set width of the black mark should be greater than the actual value. If the actual width of the black mark is 10mm, the setting value can be 20mm. After inputting, click "Set". If the setting is successful, the printer will not beep.
- f. If you input 10mm for "paper-cutting position", the printer will cut paper at the position 10mm after the black mark. After inputting, click "Set". If the setting is successful, the printer will beep once.

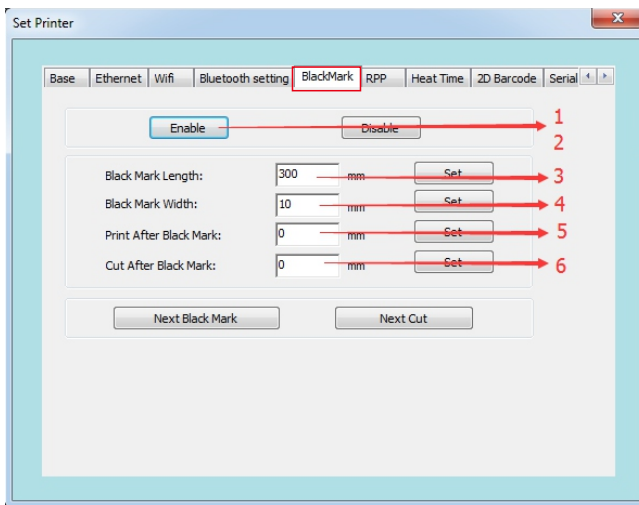

(6) Movement heating time

Enter the required heating time, and then select "Settings". After setting, print a self-test page to check whether the heating time parameter has been changed to the set value.

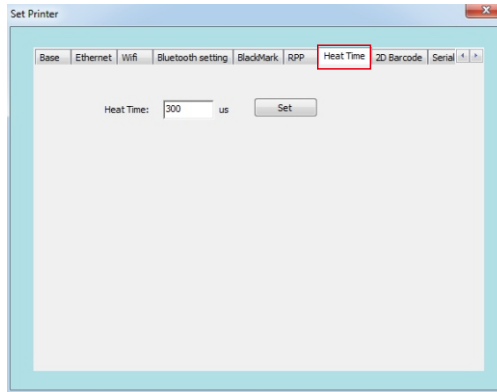

(7) "QR Code"

This function can set the printer to "Enable/disable printing of QR code". After setting, print a self-test page to check whether the QR code can be printed.

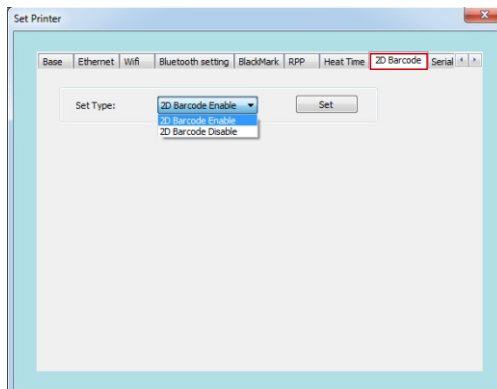

(8) Serial port Settings

You can change the serial port parameters of the printer according to your needs, such as data bits, handshake signal protocol, etc.

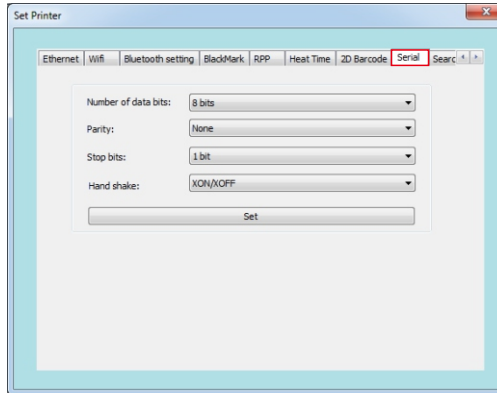

⚠ Note: After setting the serial port, the printer's serial port parameters have changed. You need to return to the main screen and reconfigure the serial port (the configuration parameters must be consistent with the parameters you modified)

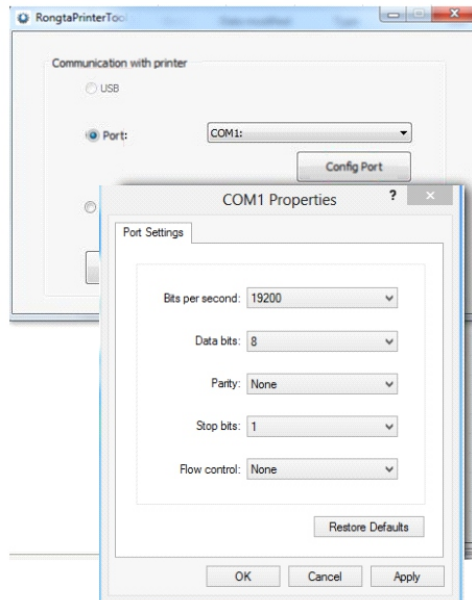

(9) Search Printer

a. Connect the network cable, select the network port, and set the corresponding IP address.

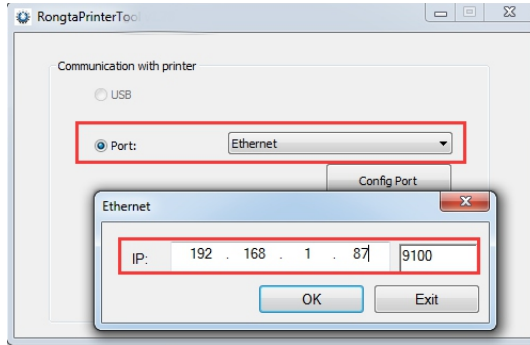

b. Select "Search for Printer". After the printer is found, the corresponding MAC address, IP address, etc. of the printer will be displayed. Select the printer and then perform related configuration or operation.

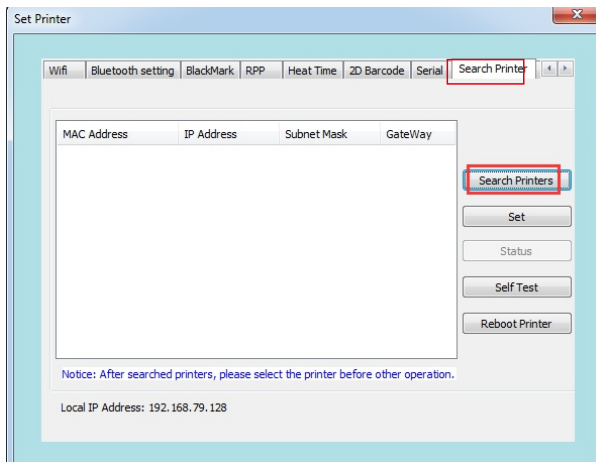

(10) Command Type Setting

There are two types of commands: label command and ESC/POS command.

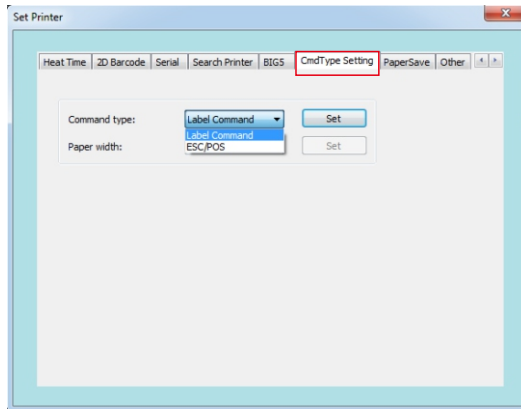

(11) Paper saving

As shown in the figure below, the paper saving settings are on the left, and the right side is divided into normal paper and paper saving previews. After setting, click "Set"

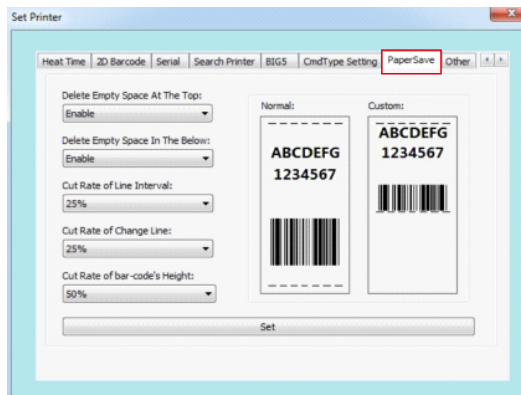

(12) Other setting

You can set the serial number, etc. in "Others".

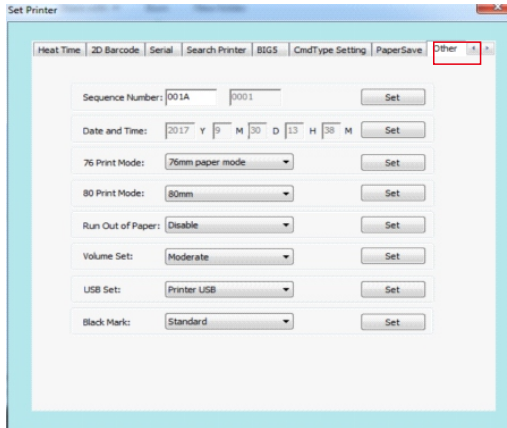

In USB setting interface (function), you can set USB as the virtual serial port and click "Set"; after successful setting, the printer will automatically shut down and you need to restart the printer manually; after restarting, go to the home screen to configure the serial port, and then the serial port printing function can be used. (Note: This function is a custom function, which cannot be used without special customization)

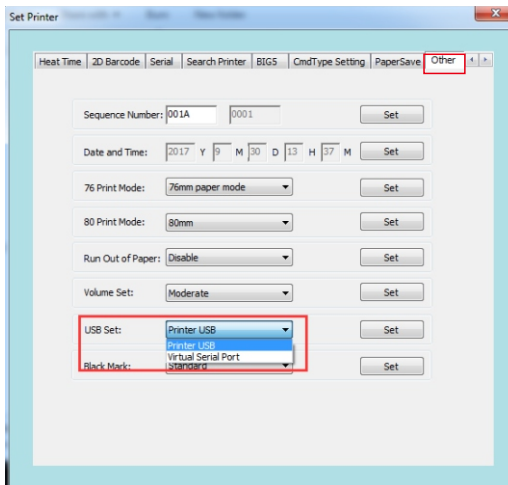

V. Page change parameter operation description

In addition to using the WINDOWS application software provided by us, the printer can also update the network port parameters through the browser (such as Internet Explorer /Firefox).

5.1 Obtaining the IP address of the Printer

Connect the printer to the power adapter, press the FEED key and turn on the power switch, wait 1-2 seconds for the printer to automatically print out the self-check page, and find the IP address in the description of the self-check page, the default is 192.168.1.87.

5.2 Connect the printer

(1) Direct connection with network cable

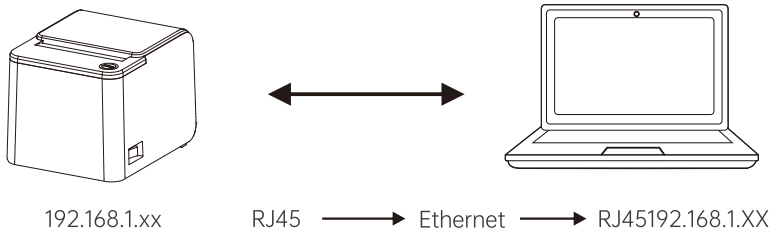

Printer and PC shall use the IP Address of the same network segment, for example 192.168.1.xx

For example, printer: 192.168.1.87, PC: 192.168.1.87

(2) Connect through a network device

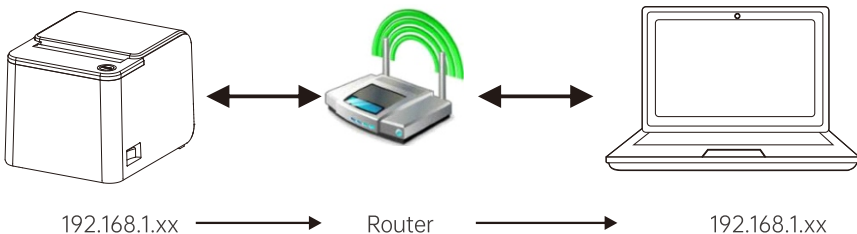

Printer and PC shall use the IP Address of the same network segment, for example 192.168.1.xx

For example, printer: 192.168.1.87, Router: 192.168.1.1, PC: 192.168.1.87

5.3 Change parameters

(1) Set pages

Open a browser, for example Microsoft IE, enter the printer IP address, and then press Enter.

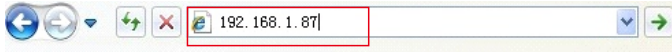

(2) View interface information

After entering the web page, you will first see the printer interface information

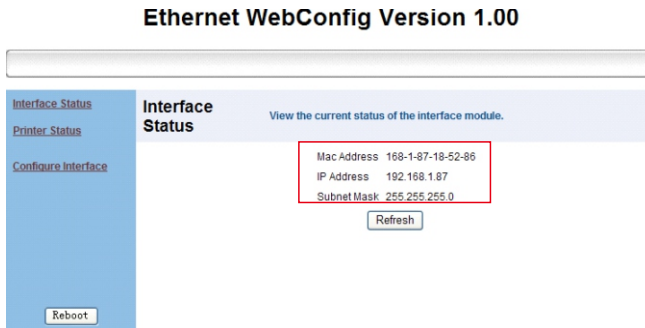

(3) View the current status of the printer

Click the link "Printer Status" on the left to view the printer status:

- 5.1 Whether the upper cover is open.
- 5.2 Whether there is diffusion knife error.
- 5.3 Whether the printing paper runs out.
- 5.4 Whether the printing paper is about to run out.
- 5.5 Whether the printer is offline, As shown in the following figure

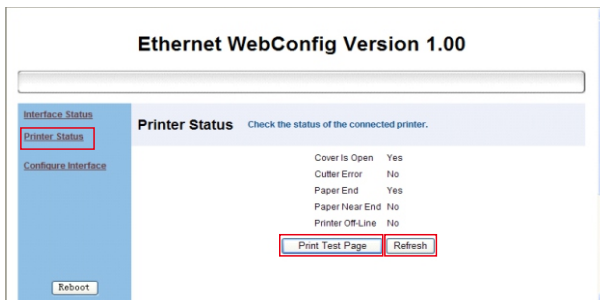

Click **Print Test Page** , to print a self-test page.

Click **Refresh** to refresh the page and view the latest status.

5.4 Set Ethernet port parameters

Click "Configure Interface" to enter the Ethernet port parameters setting interface

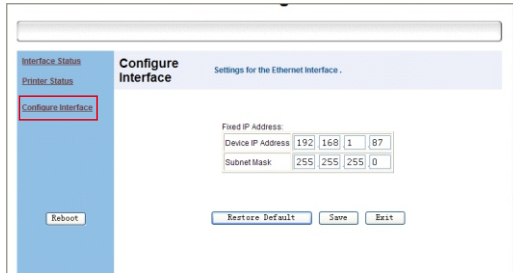

Enter a new parameter, as shown below, new IP:192.168.1.86, and click Save.

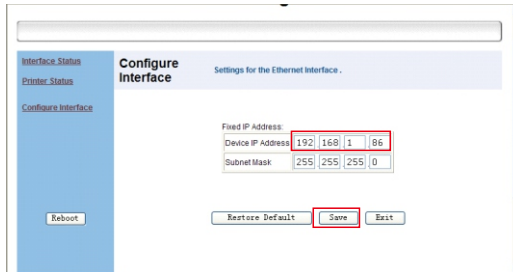

A dialog box appears, as shown in the following figure, select OK.

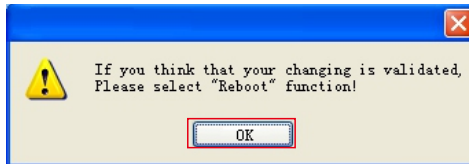

Then click the Reboot button on the left to restart the printer. The dialog box appears and select OK, as shown below

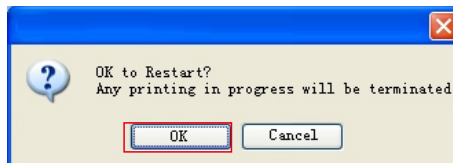

After clicking OK, the interface as shown below appears.

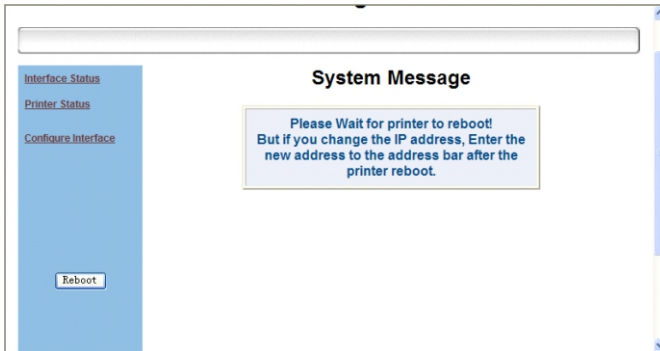

Wait a few seconds, hear the printer "drip" sound, indicating that the restart is complete. The network port parameters have been modified. To continue, enter the latest IP address in your browser and repeat the steps above. As shown in the figure below.

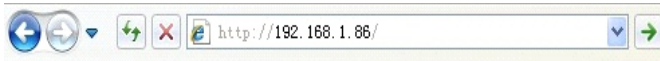

VI. Clean the printer

6.1 Clean print head

The print head should be cleaned when one of the following occurs in the printer:

- (1) the print is not clear;
- (2) A vertical column of the printed page is not clear;
- (3) The paper feed noise is large.

Print head cleaning steps are as follows:

- (1) Turn off the power of the printer, open the front cover, if there is paper, remove the paper;
- (2) If you have just finished printing, wait for the print head to cool completely;
- (3) Wipe the dust and stains on the surface of the print head with a soft cotton cloth dipped in alcohol;
- (4) Wait for the alcohol to completely volatilize, close the front cover, and re-test the printing machine.

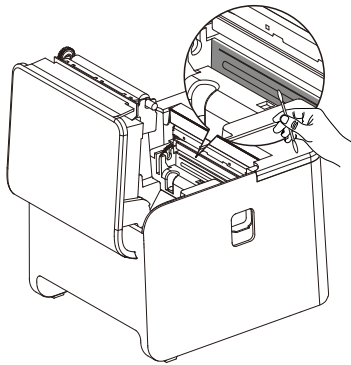

6.2 Cleaning sensor

When the printer has one of the following conditions, the paper sensor should be cleaned:(1) During the printing process, the printer occasionally terminates the printing and alarms the lack of paper;(2) No alarm for lack of paper.Clean the sensor as follows:(1) Turn off the power of the printer, open the front cover, if there is paper, remove the paper;(2) Wipe the dust and stains on the sensor surface with a soft cotton cloth dipped in alcohol;(3) Wait until the alcohol is completely volatilized, close the front cover, and re-test the machine.

6.3 Clean the printing roller

When the printer appears one of the following conditions, the printing roller should be cleaned:

- (1) the print is not clear;
- (2) A vertical column of the printed page is not clear;
- (3) The paper feed noise is large.

Printing roller cleaning steps are as follows:

- (1) Turn off the power of the printer and open the front cover;
- (2) Wipe the dust and stains on the surface of the printing roller with a soft cotton cloth dipped in alcohol;
- (3) After the alcohol is completely volatilized, close the top cover.

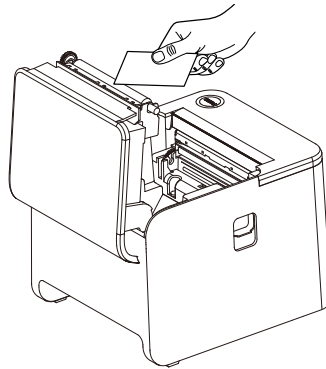

Note:

- (1) The power supply must be turned off during daily maintenance of the printer.
- (2) Do not touch the surface of the print head with hands and metal objects, and do not use tools such as tweezers to scratch Print heads, print rollers and sensor surfaces.
- (3) Do not use gasoline, acetone and other organic solvents.
- (4) Wait until the alcohol is completely volatilized, and then turn on the power to continue printing.

VII. Troubleshooting

If the printer is faulty, refer to this section to rectify the fault. If the problem still cannot be rectified, Please contact your distributor or manufacturer.

7.1 Indicators on the control panel are off

Check that the power cord is properly plugged into the printer, power adapter, and power outlet. Check that the power switch of the printer is on.

7.2 The indicator is normal, but the printer does not print

Run a self-test to check that the printer is working properly. If you can't self-check, please check with the dealer or Contact technical service personnel.

If the self-test works properly, check the following:

(1) Check the interface at both ends of the connection between the printer and the computer. At the same time, verify that the connection meets the specifications of both the printer and the computer.

(2) Data transfer Settings between the printer and the computer may differ. You can use self-test to print out the interface Settings of the printer. If the printer does not print, contact your dealer or technical support.



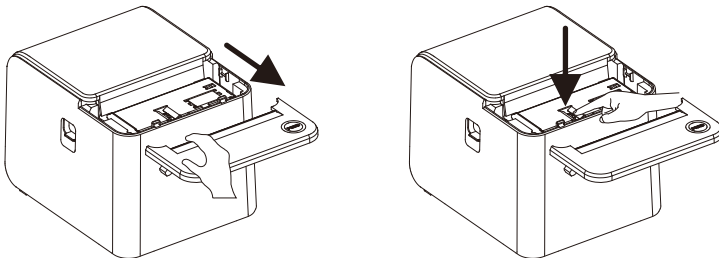

7.3 Clearing clip

When the printer has a knife jam, the upper cover of the printer cannot be opened. Power off the printer and restart it. If the jammed knife does not return to its position, you need to turn off the power of the printer, open the front cover of the printer (as shown on the left), and turn the gear in the opposite direction. Release the jammed knife. (The gears are positioned as shown in the picture below)



Appendix 1 Interface information

Printer interface

Diagram	Type	Illustration
	USB	Universal USB Interface (Standard Type B)
	Network interface	Standard RJ45-8P interface, 10M/100M transmission speed with self-adaptation, 100M network LED indication, data communication LED indication.
	Cashbox Interface	The 6-wire RJ-11 socket, outputting DC 24V/1A power signal to drive the cashbox.
	Power interface	Power plug DC 24V.

☺ Note: The interface is optional or customized, and the specific interface is subject to the actual object.

(1) USB interface

The USB interface socket of the thermal receipt printer is standard USB type-B

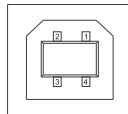

Pin number	Definition
1	VBUS
2	D-
3	D+
4	GND

(2) Ethernet interface

The Ethernet interface socket of the thermal receipt printer is standard RJ-45-8P, supporting 10M/100M network, and the transmission speed is adaptive.

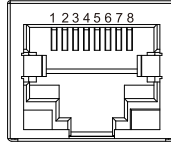

Pin number	Description	Instructions
1	TX+	Send differential line +
2	TX-	Send differential line -
3	RX+	Receive differential line +
4	NC	non-function
5	NC	non-function
6	RX-	Receiving difference line -
7	NC	non-function
8	NC	non-function

(3) Cash box interface

The printer's cash box mouth adopts RJ-11 standard, 6-wire socket, output DC 24V/1A power signal to drive the cash box action. Insert the RJ-11 crystal tip of the cash box into the cash box connector to open the cash box through the printer.

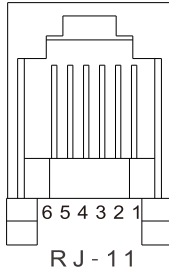

The pin functions of the printer's cash box interface are defined as follows:

Pin number	Signal	Instructions
1	GND	Electrically
2	Dk1	cash box 1# negative terminal
3	DK-1N	Enable detection
4	PWR	Power/cash box positive
5	Dk2	cash box 2# negative terminal
6	GND	Electrically

☺ Select the interface definition above to purchase the cash box.

Appendix 2 Description of special connection functions

WiFi function (optional)

WiFi is a technology that allows electronic devices to connect to a wireless local area network (WLAN), currently used by company printers. The 2.4G radio frequency band is used. Connections to wireless LANs are usually password protected; but it can also be open, so that any device within the WLAN range can be connected. For specific WiFi setting steps, please refer to the "WiFi" setting in the thermal receipt printer tool manual.

Bluetooth function (optional)

Bluetooth is a radio technology that enables devices to communicate over short distances (generally within 10m). Enables wireless information exchange between a wide range of devices including mobile phones, PDAs, wireless headsets, laptops, and related peripherals. The Bluetooth standard is IEEE802.15, which works in the 2.4GHz band with a bandwidth of 1Mb/s. Refer to the "Bluetooth" Settings in the integration tool setup manual.

a. Bluetooth pairing and printing (only valid for printers with Bluetooth)

Before working, the Bluetooth printer needs to be paired with the master device that drives the printer, and the pairing process is initiated by the master device.

The usual pairing method is as follows:

- (1) Turn on the printer
- (2) The master device searches for external Bluetooth devices
- (3) If there are multiple external Bluetooth devices, select the printer corresponding to the BDA address (see the self-test page)
- (4) Enter the initial password "0000" or "1234"
- (5) Complete the pairing.

Please refer to the main device Bluetooth function description for specific pairing methods. When pairing, the thermal receipt printer with Bluetooth interface must be turned on.

 **Note:** When pairing, do not turn on multiple printers at the same time, otherwise you may not be able to determine which printer is successfully paired.

After successful pairing, other master devices can still be paired with the printer, each printer can be paired with a maximum of 8 machines, if more master devices are paired with the printer, then the first master device with the printer will be automatically cleared from the pairing list, at this time if the master device needs to drive the printer to print, need to be paired again. (Only for multi-connected Bluetooth)

b. Print using Bluetooth interface (only valid for printers with Bluetooth)

For the main device with a virtual Bluetooth serial port (such as a SMARTPHONE, POCKET PC, PALM, notebook, computer, etc.), after pairing successfully, you can send print data to the printer through the virtual Bluetooth serial port for printing. If the master device does not have a virtual Bluetooth serial port, to drive the printer to print, please consult the master device supplier.



Rongta Technology (Xiamen) Group Co., Ltd.

ADD: No.88, Tonghui South Road, Tongan, Xiamen, China.

WEB: www.rongtatech.com TEL: 0086-592-5666129

FAX: 0086-592-5659169

